

San José

Javier Caboblanco

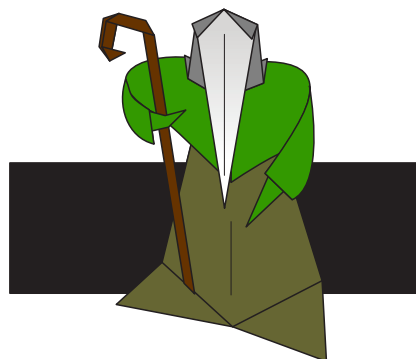

Piernas y Pies

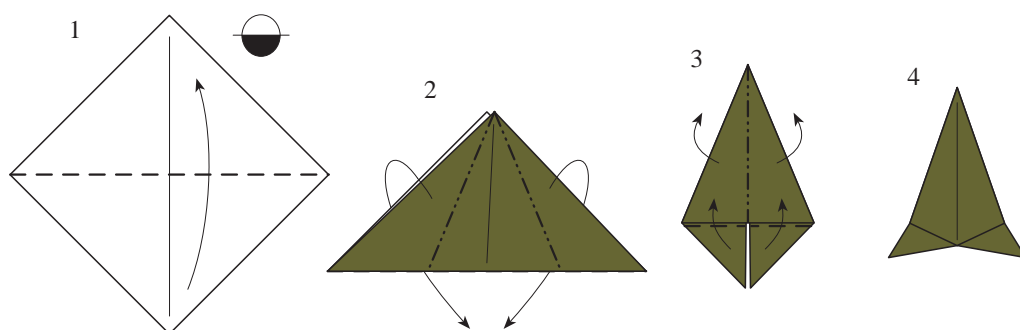

Pecho y Brazos

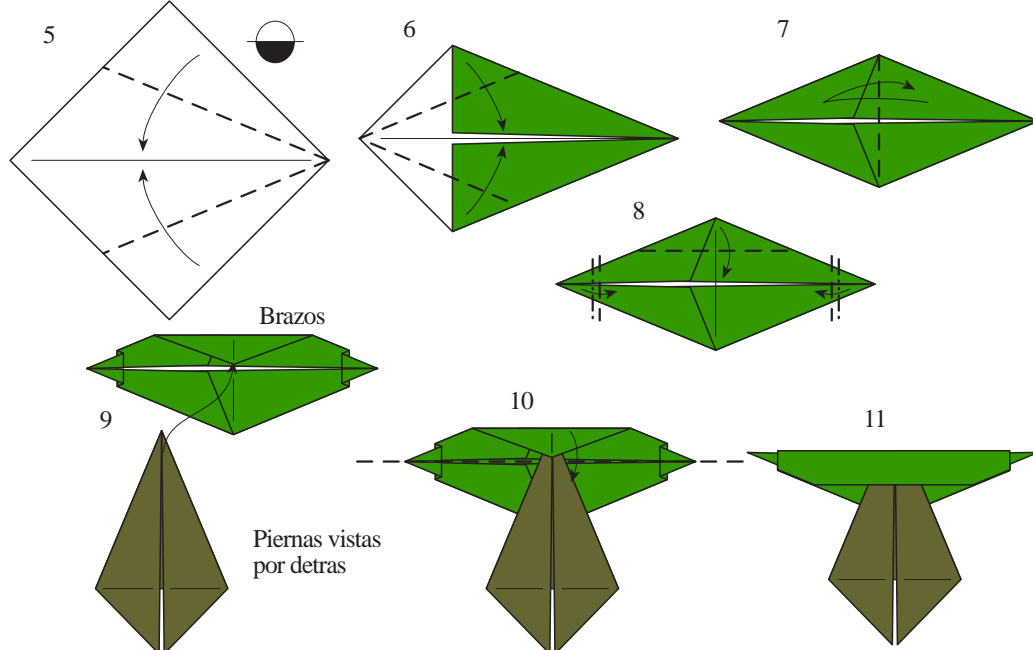

ASOCIACIÓN ESPAÑOLA DE PAPIROFLEXIA
APTDO. DE CORREOS 13.156 - 28080 MADRID
CORREO ELECTRÓNICO: aepinet@publynet.com
www.publynet.com/aep

Cabeza y Barba

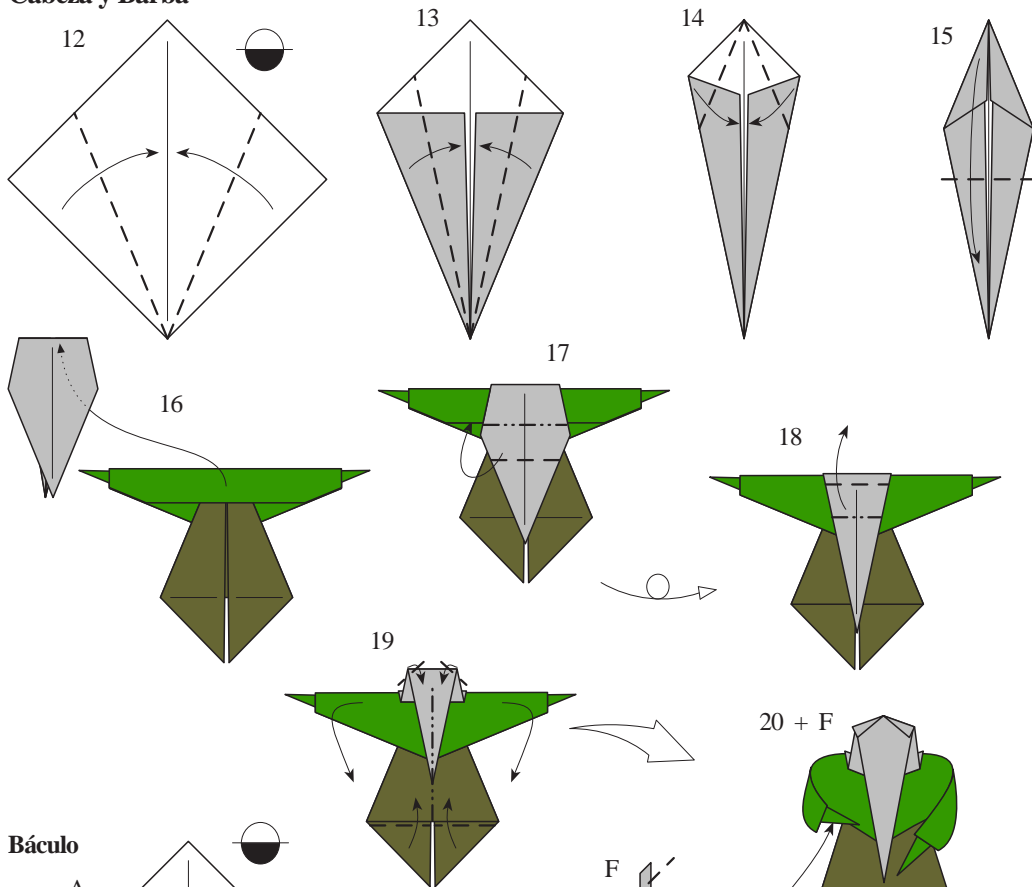

Báculo

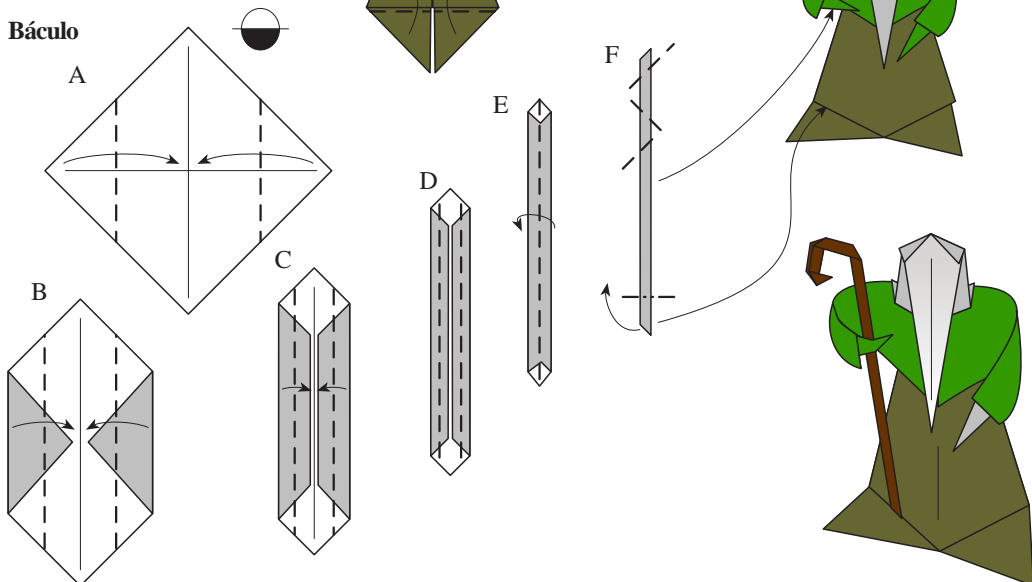

Virgen María

Javier Caboblanco

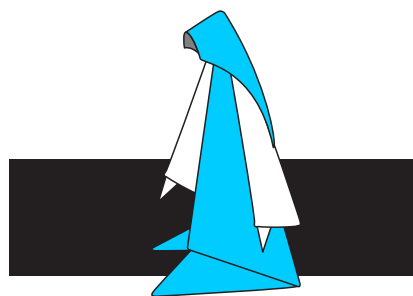

Tronco y Pies

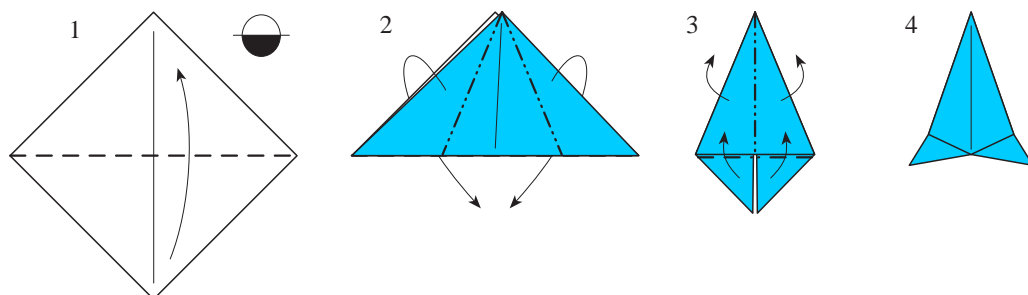

Brazos y Velo

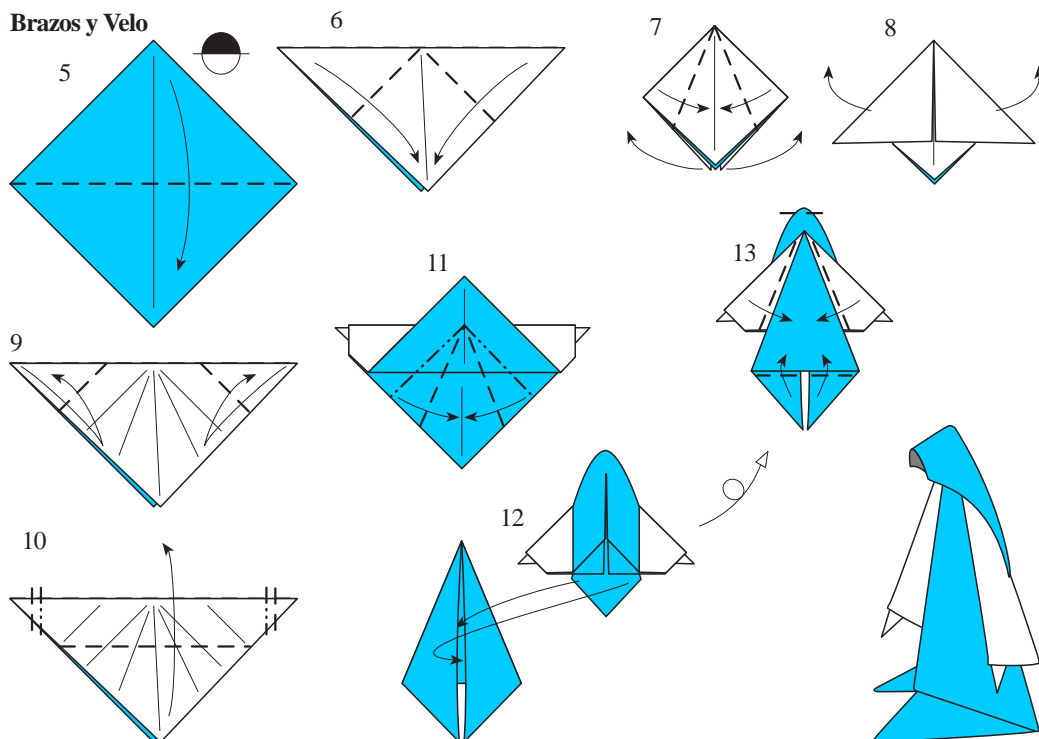

Niño Jesús

Javier Caboblanco

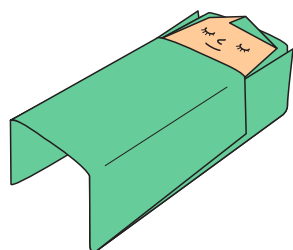
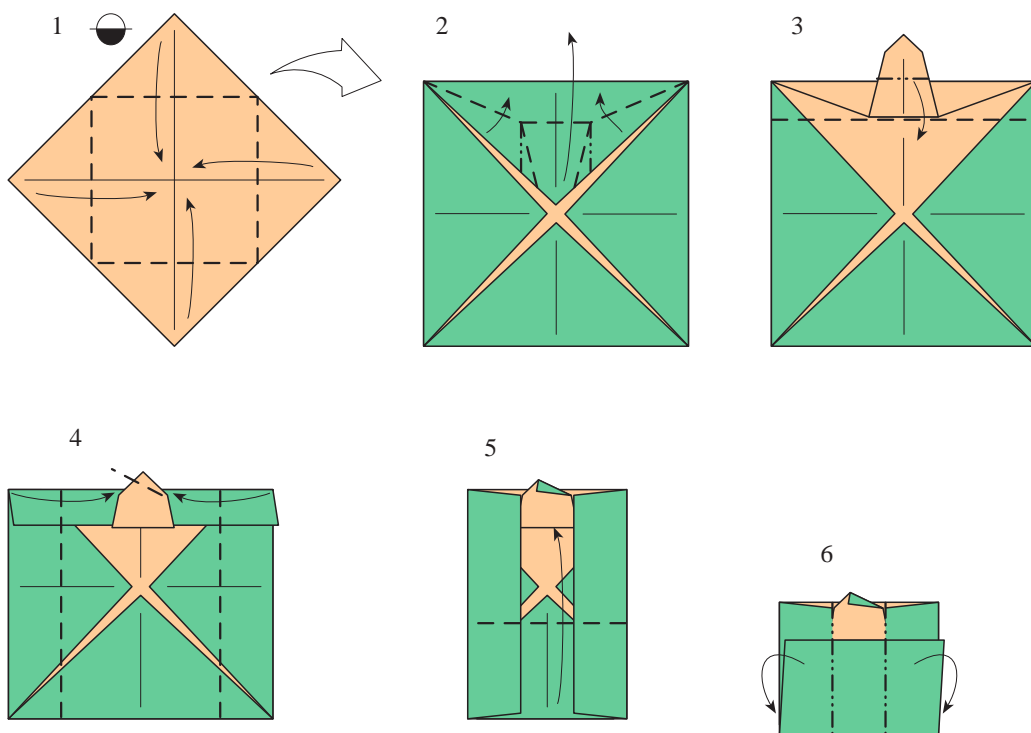
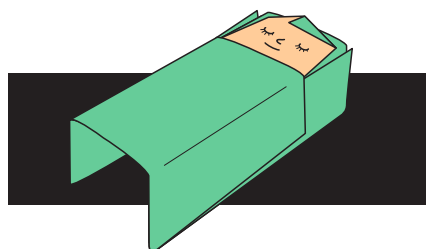

ASOCIACIÓN ESPAÑOLA DE PAPIROFLEXIA
APTDO. DE CORREOS 13.156 - 28080 MADRID
CORREO ELECTRÓNICO: aepinet@publynet.com
www.publynet.com/aep

Estrella de Belén

Javier Caboblanco

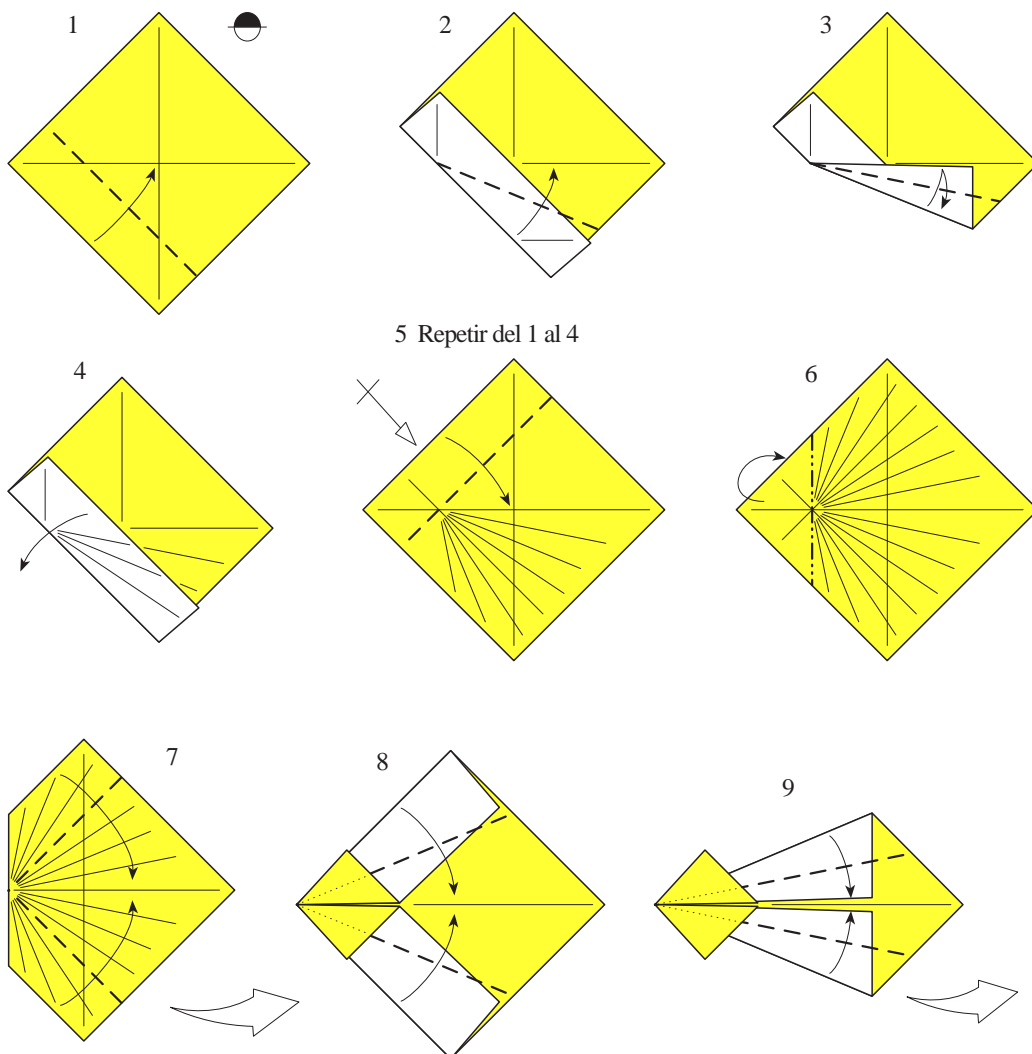
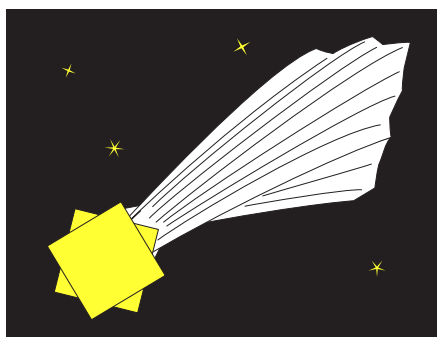

ASOCIACIÓN ESPAÑOLA DE PAPIROFLEXIA
APTDO. DE CORREOS 13.156 - 28080 MADRID
CORREO ELECTRÓNICO: aepinet@publynet.com
www.publynet.com/aep

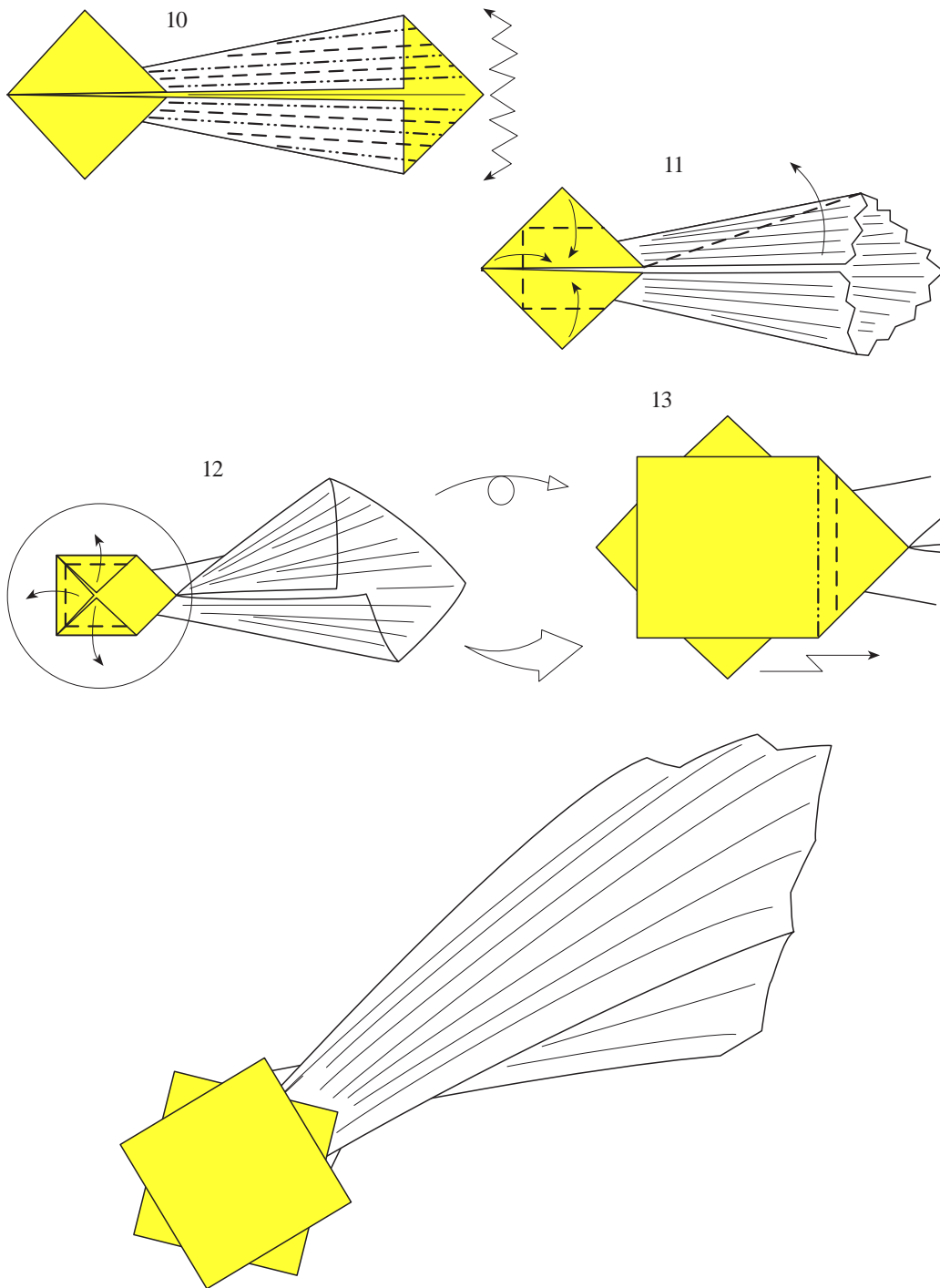

Ángel

Javier Caboblanco

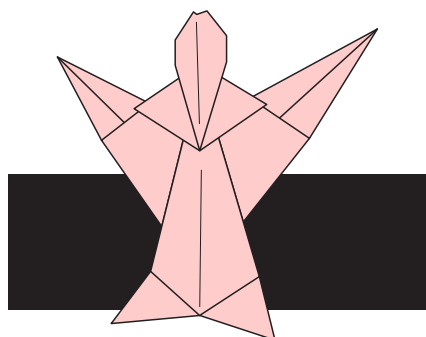

Piernas y Pies

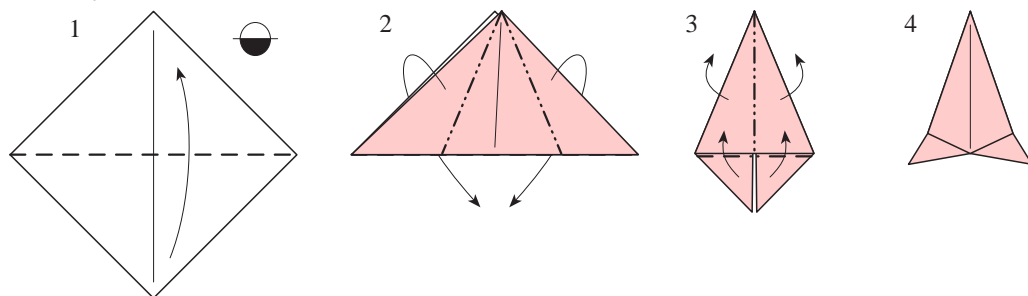

Cuerpo

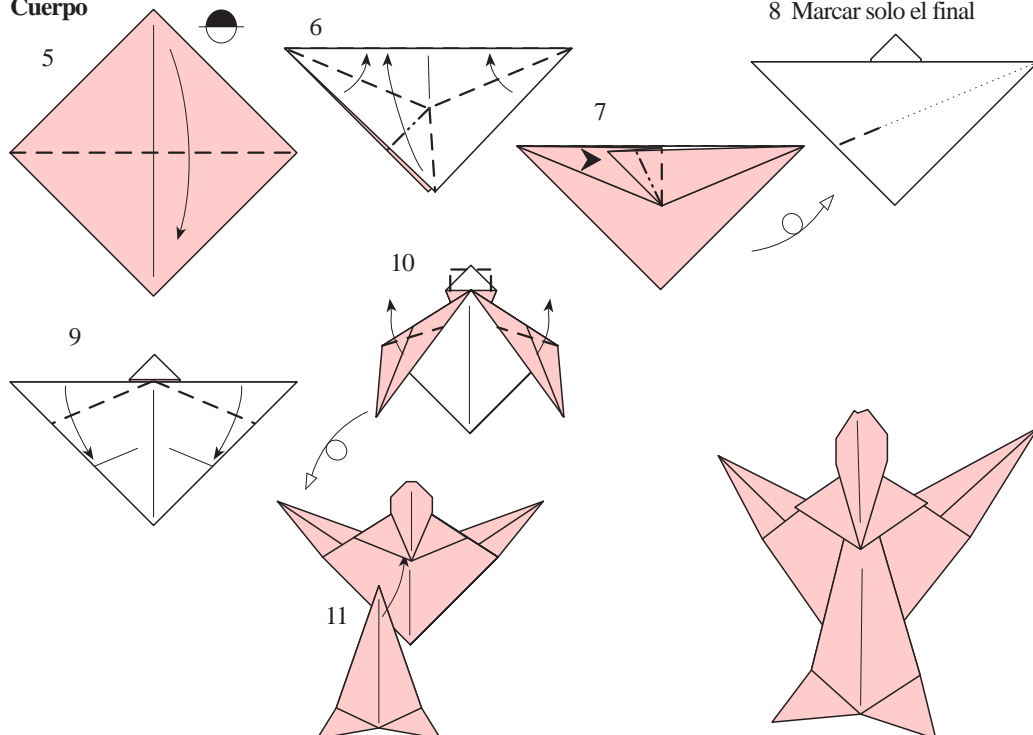

Oveja

Javier Caboblanco

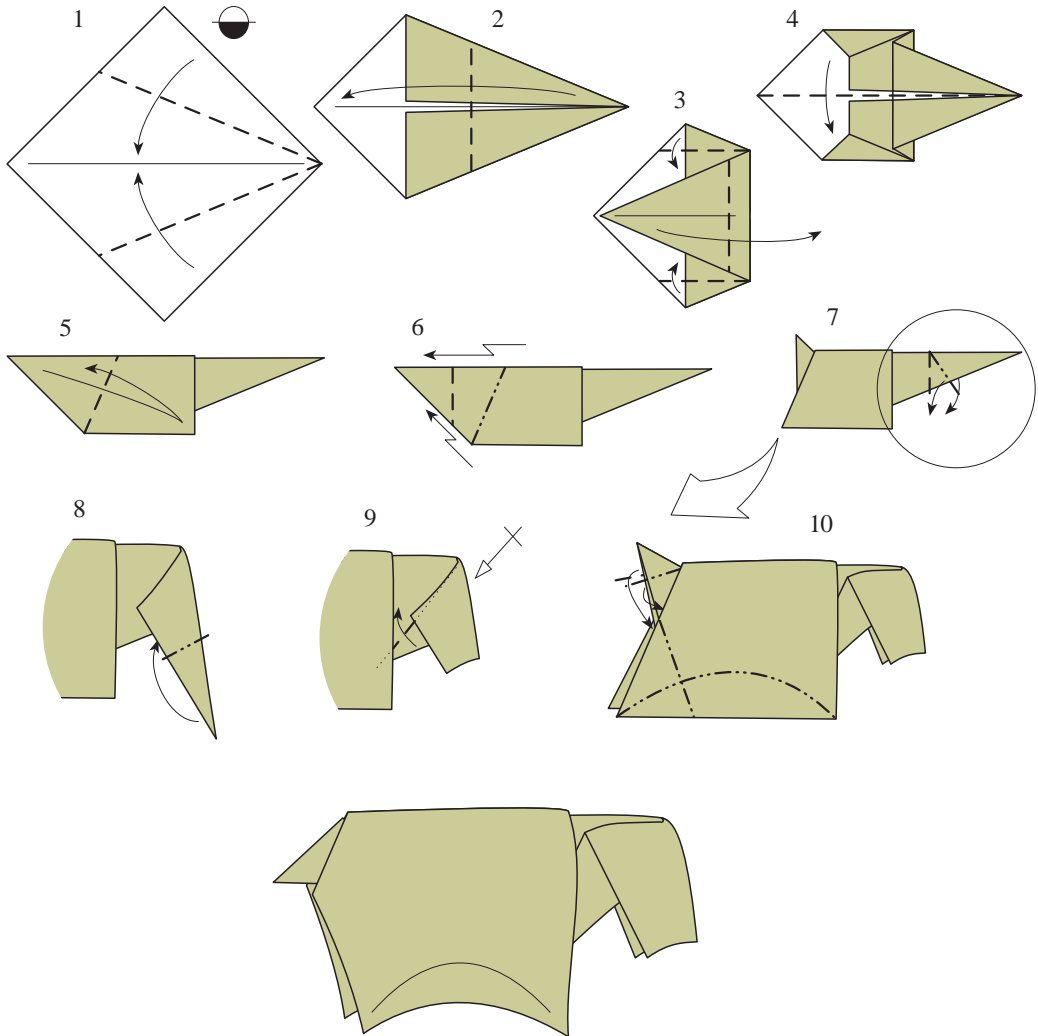
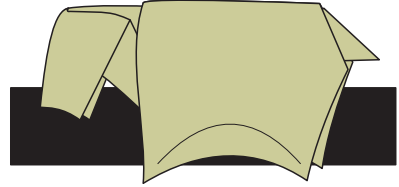

ASOCIACIÓN ESPAÑOLA DE PAPIROFLEXIA
APTDO. DE CORREOS 13.156 - 28080 MADRID
CORREO ELECTRÓNICO: aepinet@publynet.com
www.publynet.com/aep